

TB260 BOPLAN SAFETY BARRIER SPECIFICATION SHEET

Revision: 10 August 2021 4:25 PM
Boplan reference: TB260 ...







PRODUCT SPECIFICATIONS

APPLICATION			
Environment	The TB260 is ideal for protecting against damage caused by forklift manoeuvres. The lower tube prevents goods or pallets sliding under the barriers and hitting pedestrians or causing damage to machines or equipment.		
Impact performance at 90° (in JOULE)	POST:	12000 Joule (Eq. to 5ton - 7,9 km/h)	
	RAIL:	21200 Joule (Eq. to 5ton - 10,5 km/h)	
MATERIAL			
Posts and rails	Polyolefin - UV resistant - Fire class E ⁺ - Non conductive - Impervious to most chemicals ^{**}		
Caps	SEBS rubber		
STANDARD COLORS			
End post	Yellow		
Mid post	Yellow		
Tubes (rails)	Yellow		
BASEPLATES			
	Steel	Zinc Coated Steel	Stainless Steel
Material	Steel 37	Steel 37	Stainless steel (SS 304)
Coating	Lacquered	Lacquered + electro plating	No lacquer / No coating
Color	High gloss black	Matt black	Natural color

*Classification according to EN 13501-1:2007 +A1:2009 - Fire classification of construction products and building elements.
**Ask your local sales office for resistance to specific chemicals.

FIXATIONS

		ZC (Zinc coated)	SS (Stainless steel)
STANDARD	Wedge anchor	 M12 x 120mm	M12 x 120mm
	Wedge anchor Countersunk	 Not available	Not available
	Anchor rod (Chemical)	 M12 x 120mm + Chemical resin	M12 x 120mm + Chemical resin
ALTERNATIVES	Concrete screw	 Ø12mm x 100mm	Ø10mm x 100mm
	Asphalt anchor	 Bolt M10 x 40mm + Screw Ø16mm	Not available
	Spit anchor	 Bolt M12 x 100mm + Plug Ø20mm	Not available

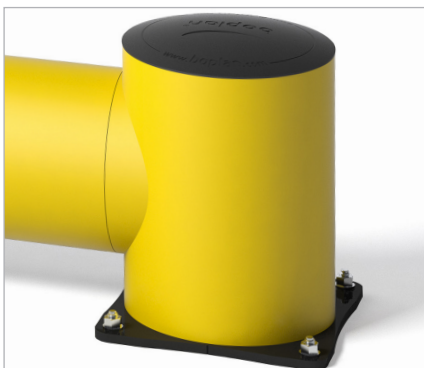

FEATURES AND FUNCTIONALITY TB260

SIZE	
Height end posts	300 mm
Height mid post	260 mm
Profile section tubes	Ø200 mm (11 mm thick)
Profile section end posts	Outer tube: Ø250 mm (11 mm thick) Inner profile: 112 mm x 112 mm (10 mm thick)
Profile section mid posts	Profile: 112 mm x 112 mm (10 mm thick)
Standard rail length	1350 mm (other sizes: 750 mm - 1750 mm)
Baseplate	End Post: 275 mm x 275 mm (10mm thick) Mid Post: 180 mm x 180 mm (10mm thick)

REQUIREMENTS	
Concrete quality	minimum C25/30
Concrete floor plate thickness	minimum 150 mm
Concrete slab dimension around posts (mm)	600 (h) x 600 (w) x 500 (d)
Operational temperature	-10°C up to +40°C
Water and humidity	Steel (standard): dry indoor use only. Zinc coated: outdoor use in most environments. Stainless steel: outdoor use or frequent exposure to water and humidity.

IMPACT LABEL FOR SAFETY BARRIERS

BOPLAN TB260		
IMPACT RATING	45°	90° <small>PAS 13:2017 compliant</small>
E80 > 80 kJ		
E60 > 60 kJ		
E50 > 50 kJ		
E40 > 40 kJ		
E35 > 35 kJ	30,0 kJ	
E30 > 30 kJ		
E25 > 25 kJ		21,2 kJ
E20 > 20 kJ		
E15 > 15 kJ		
E10 > 10 kJ		
E5 > 5,0 kJ		
E2 > 2,5 kJ		

TEST CONDITIONS

TEMPERATURE: 20°C
IMPACT HEIGHT: 160 mm
IMPACT ANGLE: 90°
TEST FLOOR: CONCRETE C25/30 - 160 mm
MANUFACTURER ANCHOR PULL OUT: 7,9 kN

TEST VEHICLE

WEIGHT: 2300 KG
TYPE: COMMERCIAL FORK LIFT
SIZE (L x W x h): 1890 x 1020 x 1970 mm
CONTACT AREA: STEEL BUMPER WIDTH: 600 mm

ACCREDITED TEST LABORATORY

620 Route des Fromentaux
01500 Saint-Maurice-de-Rémens
01360 Beligneux
France

SUCCESS CRITERIA VEHICLE STOPPED - ASI (ACCELERATION SEVERITY INDEX) < 0.5

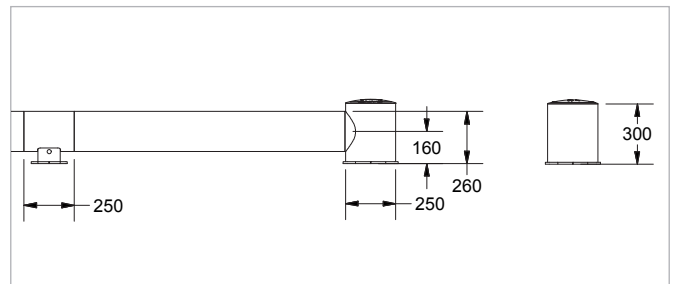
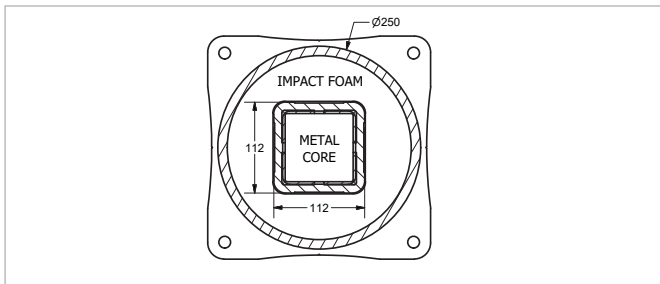
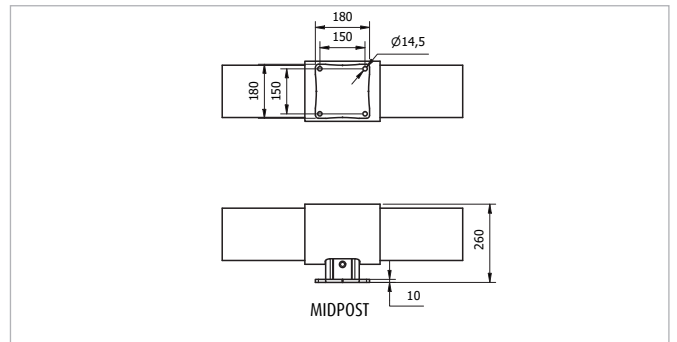
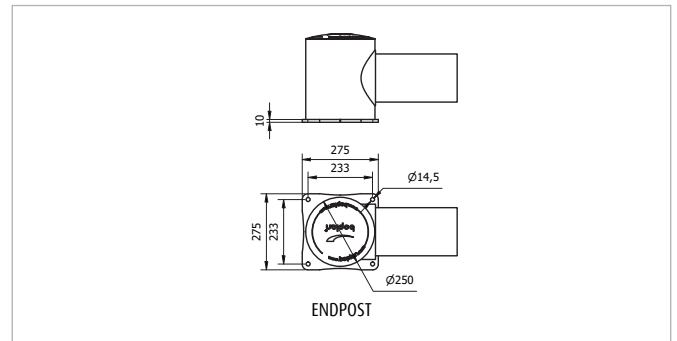

REFERENCE LIST - TB260

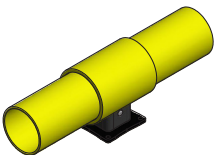
POSTS		
End post End post - ZC End post - SS	TB2600-0001-EPYE TB2600-0001-EPYEZ TB2600-0001-EPYES	
Mid post Mid post - ZC Mid post - SS	TB2600-0001-MPYE TB2600-0001-MPYEZ TB2600-0001-MPYES	

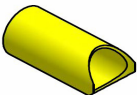
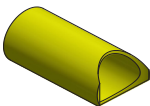
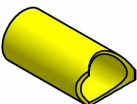
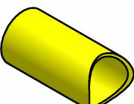
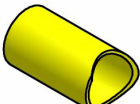
CURVES		
Conn.tube Ø200 Curve 350mm - YE	TB2600-0350-C200YE	
Conn.tube Ø200 - 45° Curve 350mm - YE	TB2600-0350-C204YE	
Conn.tube Ø200 - 90° Curve 350mm - YE	TB2600-0350-C209YE	
Conn.tube Ø250 Curve 350mm - YE	TB2600-0350-C250YE	
Conn.tube Ø250 - 90° Curve 350mm - YE	TB2600-0350-C259YE	

RAIL SETS			
	Tube length (A)	CC length (B)	Reference
Standard rail	750 mm	1000 mm	TB2600-0750-1000YE
Standard rail	950 mm	1200 mm	TB2600-0950-1200YE
Standard rail	1150 mm	1400 mm	TB2600-1150-1400YE
Standard rail	1350 mm	1600 mm	TB2600-1350-1600YE
Standard rail	1550 mm	1800 mm*	TB2600-1550-1800YE
Standard rail	1750 mm	2000 mm*	TB2600-1750-2000YE
Short rail	600-1349 mm	850-1599 mm	TB2609-1599-SRYE
Long rail	1351-1749 mm	1601-2000 mm*	TB2609-2000-LRYE

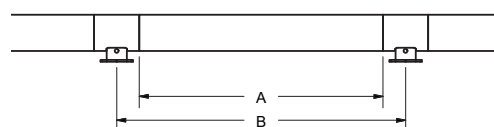

* The impact performance has not been tested for tube lengths > 1600 mm. Only use these lengths for non-critical applications.

REFERENCE LIST - TB260

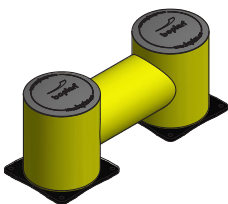
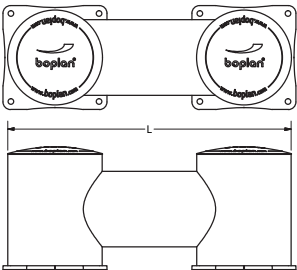
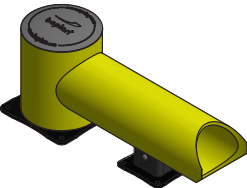
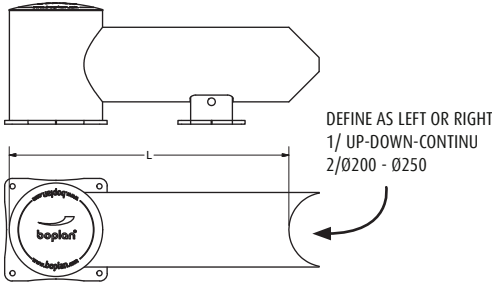
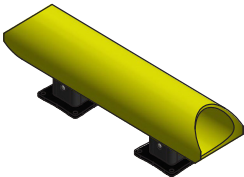
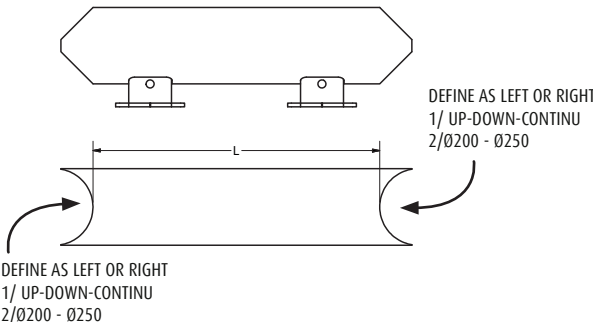
FIXED UNITS					
TYPE	LENGTH	BASE	YELLOW		
no curves	750 mm	Steel ZC SS	TB2600-0750-FUYE TB2600-0750-FUYEZ TB2600-0750-FUYES		
	751-1750 mm	Steel ZC SS	TB2601-1750-FUYE TB2601-1750-FUYEZ TB2601-1750-FUYES		
1 curve	750 mm	Steel ZC SS	TB2600-0750-FU1CYE TB2600-0750-FU1CYEZ TB2600-0750-FU1CYES		
	751-1750 mm	Steel ZC SS	TB2601-1750-1CYE TB2601-1750-1CYEZ TB2601-1750-1CYES		
2 curves	750 mm	Steel ZC SS	TB2600-0750-FU2CYE TB2600-0750-FU2CYEZ TB2600-0750-FU2CYES		
	751-1750 mm	Steel ZC SS	TB2601-1750-FU2CYE TB2601-1750-FU2CYEZ TB2601-1750-FU2CYES		